

WAP/M/SPECN-1/082/2000			ALT
ALT	DATE	JOB NO.	SIGN.

GOVERNMENT OF INDIA  
 MINISTRY OF RAILWAYS

SPECIFICATION FOR  
 HYDRAULIC CYLINDER OF ROUGHING LATHE  
 CARRIAGE TRAVEL

Issued by

MECHANICAL DRAWING OFFICE  
 WHEEL & AXLE PLANT  
 YELAHANKA, BANGALORE-560 064  
 I N D I A

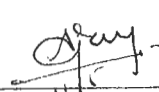
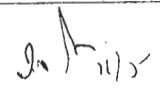
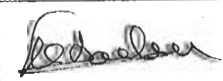
		
DY.CME/A	WM/AMS	SSE/DESIGN
APPROVED BY	CHECKED BY	PREPARED BY

**SPECIFICATION FOR  
HYDRAULIC CYLINDER OF ROUGHING LATHE CARRIAGE TRAVEL**

1. APPLICATION:

- 1.1 The application of the hydraulic cylinder is for use on a machine tool rough turning lathe for movement of tool slides.

2. SCOPE OF SUPPLY:

- 2.1 Design, manufacture, supply of hydraulic cylinders to outline dimensions given in the WAP Drawing No. 705400220120. The supply shall accompany manufacturer's test certificate along with chemical and physical properties of all the material used.

3. DESIGN OF THE CYLINDER:

The cylinder shall be of heavy duty suitable for withstanding cutting forces generated while machining a railway axle on a Rough Turning Lathe having maximum capacity of 26 mm depth of cut.

4. DUTY CYCLE:

The hydraulic cylinder shall be capable of activities in 3 shift @ 8 hours/shift continuously.

5. DRAWINGS:

Before manufacturing of the hydraulic cylinder, all the relevant drawings shall be approved by WAP. WAP will not be responsible for design/development of the cylinder.

6. GENERAL:

- 6.1 GA drawings indicating the major dimensions shall be supplied along with the tender.
- 6.2 The cross sectional view of the cylinder indicating all the dimensions, accuracies, materials, finishes, physical properties shall be supplied along with the supply.

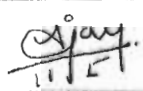
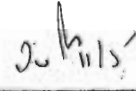
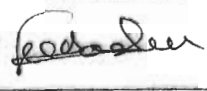
		
DY.CME/A	WM/AMS	SSE/DESIGN
APPROVED BY	CHECKED BY	PREPARED BY

- 6.3 All component details and sealing details shall be supplied along with the hydraulic cylinder.
- 6.4 All the sealing shall be of Bushak, Shamban, Parker, Merkel, Rolon, Hunger only.
- 6.5 Preference will be given to manufacturer who have -
  - 6.5.1 Full fledged in-house facilities for manufacturing this size and type of cylinders.
  - 6.5.2 Suitable test rigs with adequate facilities for testing the hydraulic cylinders.
  - 6.5.3 Who have manufactured and supplied similar size and cylinders for similar heavy duty application viz. Steel Mill, Earth Moving Machineries, Machine Tools.

7. GUARANTEE:

- 7.1 The hydraulic cylinders supplied shall be guaranteed for 18 months from the date of receipt or 12 months from the date of commissioning whichever is earlier for all manufacturing defects.
- 7.2 The supplier shall grantee for the adaptability of the cylinder.



8. TECHNICAL SPECIFICATION:

8.1 Cylinder specification:

- 8.1.1 Mounting dimension and outline dimension- Drg. No. 705400220120
- 8.1.2 Class - Heavy Duty.
- 8.1.3 Working medium - Mineral ISOVG 68.

8.2 General material specification:

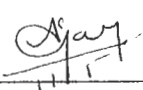
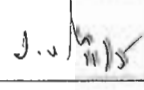
- 8.2.1 Cylinder barrel - HFS tube 5752, DIN 1629 or equivalent. Bore finish shall be finished by honing to surface finish Ra ≤ 0.3 micron.

		
DY.CME/A	WM/AMS	SSE/DESIGN
APPROVED BY   CHECKED BY   PREPARED BY		



- 8.2.2 Piston rod - EN 9/EN 8/40 C8/IS 1570 heat treated hard chrome plated to depth 40um and polished roughness Ra ≤ 0.4 um.
- 8.2.3 Piston seal - High pressure composite piston seal of imported origin made of Polyurethane and PTFE Bronze. Make of seals preferred - Boshak, Shamban, Parker, Hunger, Merkel.
- 8.2.4 Rod seal - Multiple sealing 'V' packing set, rod wiper, front adapter cum bushing of imported make viz. Boshak, Shamban, Parker, Hunger, Merkel.
- 8.2.5 Tie rods - EN 24 Q&T to a strength of 12.9 grade or better.
- 8.2.6 Fasteners - Make - Unbrako, TVS, GKW of 12.9 grade or superior.
- 8.2.7 The cylinder shall accompany manufacturer's test certificate for all details of chemical and physical properties of major critical components viz. cylinder barrel, piston rod, piston. All major components shall be ultrasonically tested for internal flaw. The supplier shall guarantee for adaptability of the cylinder

9. INSPECTION: By RITES.

9.1 At firm's premises:

9.1.1 Dimensional inspection: Measurements of all mounting dimensions, piston rod, stroke, desired centre distance as indicated in GA drawing shall be checked and recorded.

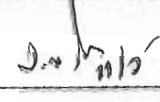
9.1.2 Verification of physical and Chemical properties: The physical and chemical properties of all major components shall be verified with the manufacturer's test certificates.

		
DY.CME/A	WM/AMS	SSE/DESIGN
APPROVED BY	CHECKED BY	PREPARED BY

9.1.3 Hydraulic cylinder shall be subjected to following tests with mineral oil as per IS 10585:1983, except for Endurance Test.

9.1.3.1 Static internal leakage test.

9.1.3.2 Static friction/packing drag test.

9.1.3.3 Cycle Test - Cylinder shall be reciprocated for 50 cycles at no load condition to ensure smooth and noise free operation. External leakage shall be checked and recorded.

9.2 At Wheel & Axle Plant:

9.2.1 **Adaptability:** The cylinder shall be mounted and checked for proper fitment and suitability.

9.2.2 **Load test:** The cylinder shall be subjected to load under actual cutting parameters for 7 days.

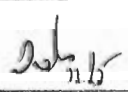
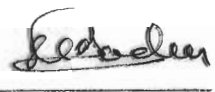
		
DY.CME/A	WM/AMS	SSE/DESIGN
APPROVED BY	CHECKED BY	PREPARED BY

DRG. No.	DESCRIPTION	JOB No.	INITIALS
3	DRG. REVISED AND RE-DRAWN	3593	Approved J.N.R.

4 HOLES TO SUIT 3/4" UNF HEX. SOC. HD. SCREWS.

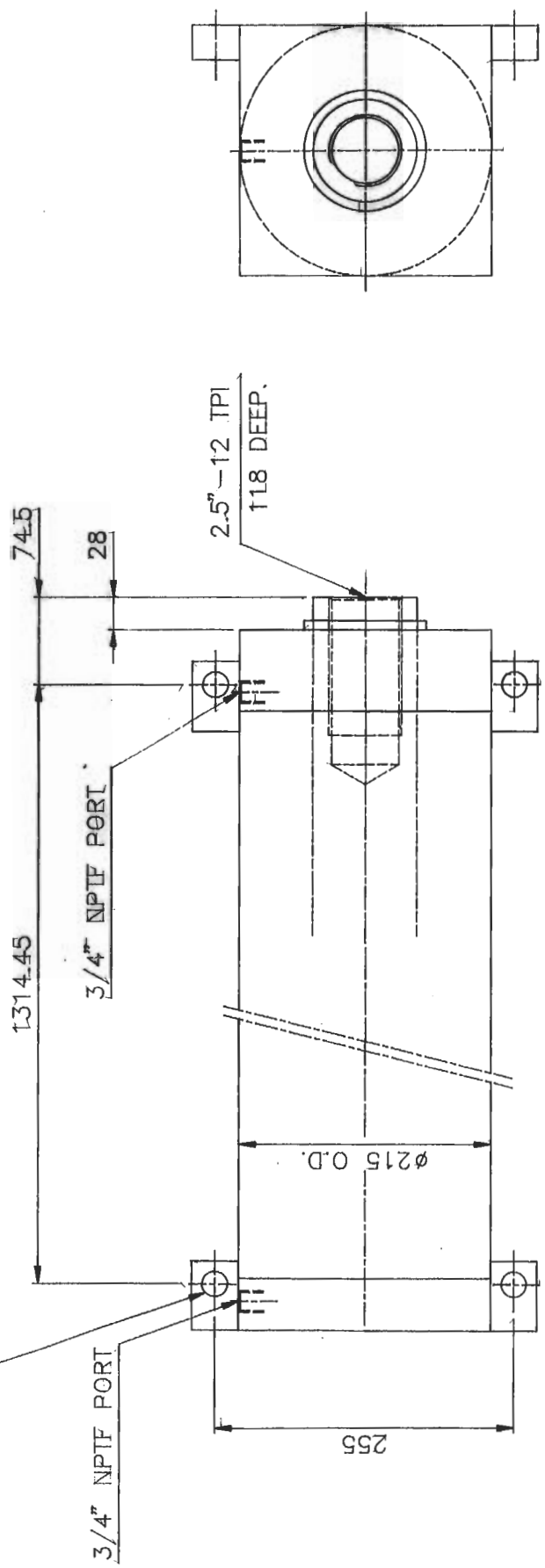

NOTE :

1. ALL DIMENSIONS ARE IN 'mm' UNLESS OTHERWISE SPECIFIED.
2. PROVISION OF THE RODS TO BE WITHIN THE RESTRICTED DIMENSIONS.

CYLINDER DATA :

1. BORE : 203.2 (8")
2. STROKE : 1219.2 (48")
3. ROD DIA. : 88.9 (3.5")
4. MOUNTING STYLE : FOOT MOUNTED
5. SEALS : 'U'-CUP TYPE
6. PORTS : 3/4" NPTF
7. CUSHIONING : NON-CUSHIONED AT BLIND END  
CUSHIONED AT OTHER END.
8. WORKING PRESSURE : 500 P.S.I.

INDIAN RAILWAYS		SUPERSEDED BY	
HYDRAULIC CYLINDER		SUPERSEDES	
FOR CARRIAGE TRAVEL		SCALE	SD
OF AXLE ROUGHING LATHE		CHD	
(FOR R.H. FRONT CARRIAGE)		TRD	
		DRN	
		ALT	
		J N R 4.5.00	
WHEEL AND AXLE PLANT		DRG. No. 735 4002 20120	
BANGALORE		JOB No. 3593	
		SHEET 1 OF 1	

APPROVED	2.5.85
MM/A	